

KLT-CMNL-OS12D40 V1.0**11.3MP OmniVision OS12D40 No Lens Camera Module**

Front View

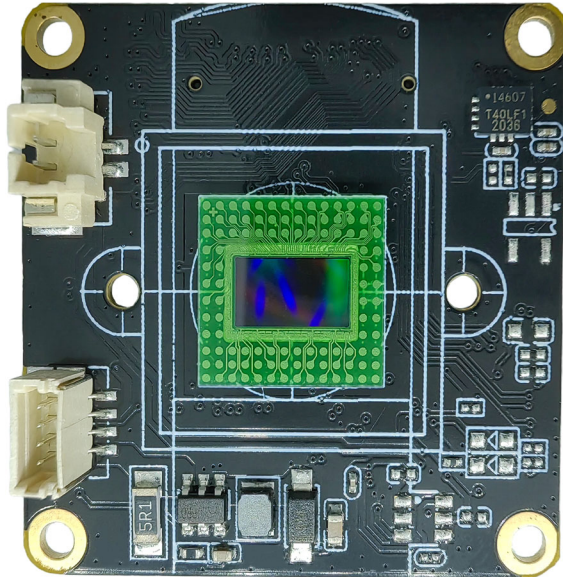
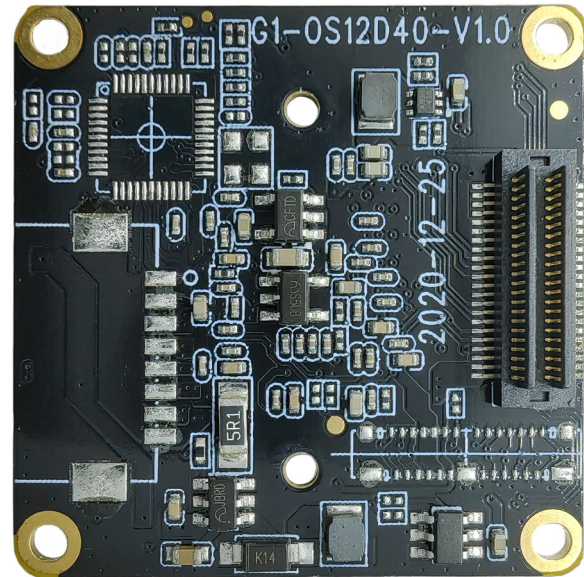

Back View

Overview

The OmniVision OS12D40 color image sensor used in the KLT-CMNL-OS12D40 V1.0 camera module No Lens sensor board is a high-performance CMOS 1/2.49" image sensor that can provide 11.3 megapixels (4512x2512) image signals at up to 60FPS, with a pixel size of 1.404um x 1.404um. Users can freely match lenses.

When used with the master board, it can support shooting 11MP high-definition images, up to 4K@60FPS (differential), and 4K@30FPS video shooting. This camera uses board-to-board socket connection.

It supports multi-axis EIS anti-shake image stabilization function. The board frame size is 32*32mm.



KLT-CMNL-OS12D40 V1.0

11.3MP OmniVision OS12D40 No Lens Camera Module

Specifications

Model No.	KLT-CMNL-OS12D40 V1.0
Image Sensor	OS12D40
Image Sensor Type	CMOS
Effective Pixels	11.3 Megapixels
Sensor Size	1/2.49"
Pixel Size	1.404 um x 1.404 um
EIS Anti-Shake (Reserved)	Supportive Electronic EIS Image Stabilization
Video Frame Rate	4K@24/25/30/FPS, 4K@48/50/60FPS (Differential) 2.7K@24/25/30/48/50/60FPS 1080P@24/25/30/48/50/60/120FPS 720P@24/25/30/48/50/60/120/240FPS
Video Format	H.264
Video Output Format	MOV (Can be Modified as MP4)
Video Slow Motion	OFF, 4K2X, 1080P4X, 720P8X
Photo Format	JPG
Photo Resolution (with Master Board)	20MP (5200x3900) (Differential) 13MP (4160x3120) (Differential) 12MP (4000x3000) 10MP (3648x2736) 8MP (3264x2448) 5MP (2592x1944) 3MP (2048x1536) 2MP (1920x1080)
Operating Temperature	-10°C to +60°C
Storage Temperature	-20°C to +80°C
Humidity	20% to 80%
PCB Dimensions	32 x 32 mm
PCB Screw Hole Spacing	28 x 28 mm
PCB Screw Hole Diameter	2 mm
Lens Mount Screw Diameter	1.6 mm

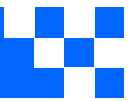
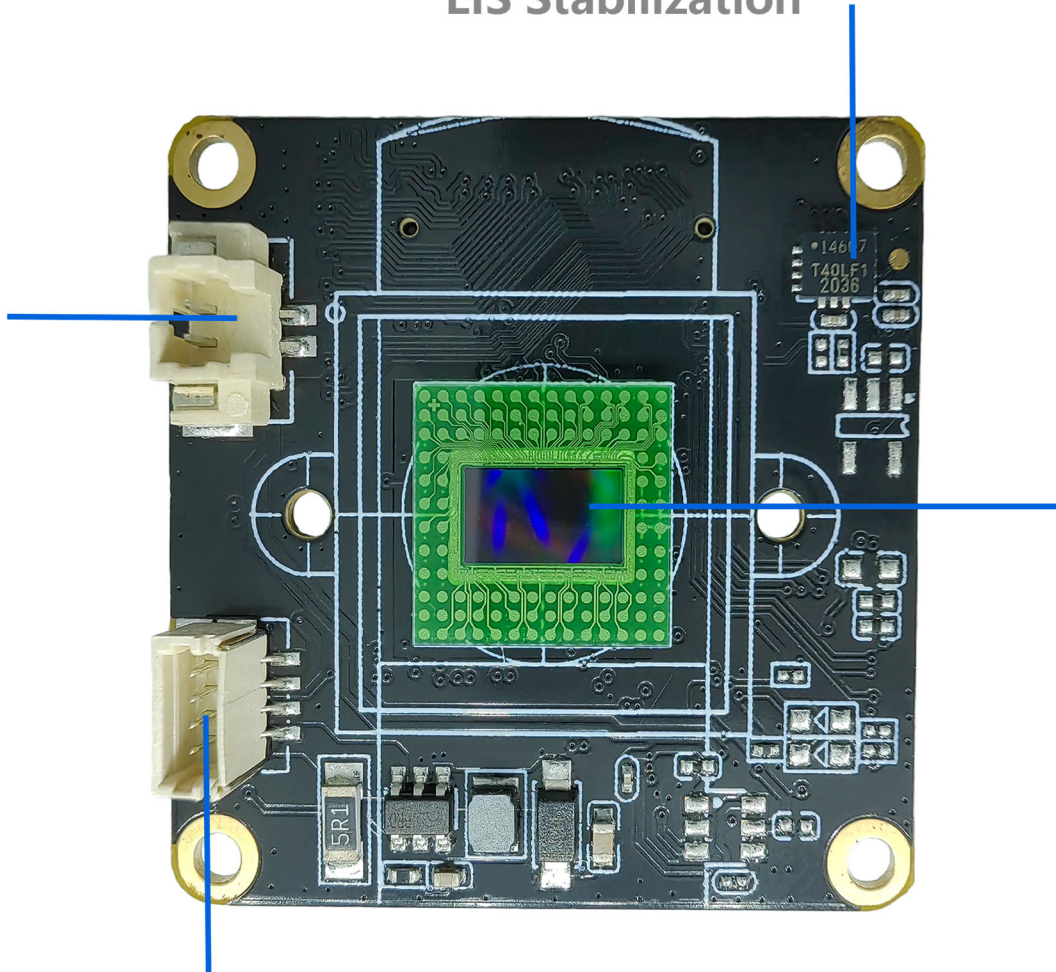
**KLT-CMNL-OS12D40 V1.0****11.3MP OmniVision OS12D40 No Lens Camera Module****陀螺仪，支持EIS防抖**
EIS Stabilization**滤光片切换器接口**
IR-CUT INTERFACE**OV OS12D40 sensor****两组LED补光灯接口**
LEDS * 2 INTERFACE



KLT-CMNL-OS12D40 V1.0

11.3MP OmniVision OS12D40 No Lens Camera Module

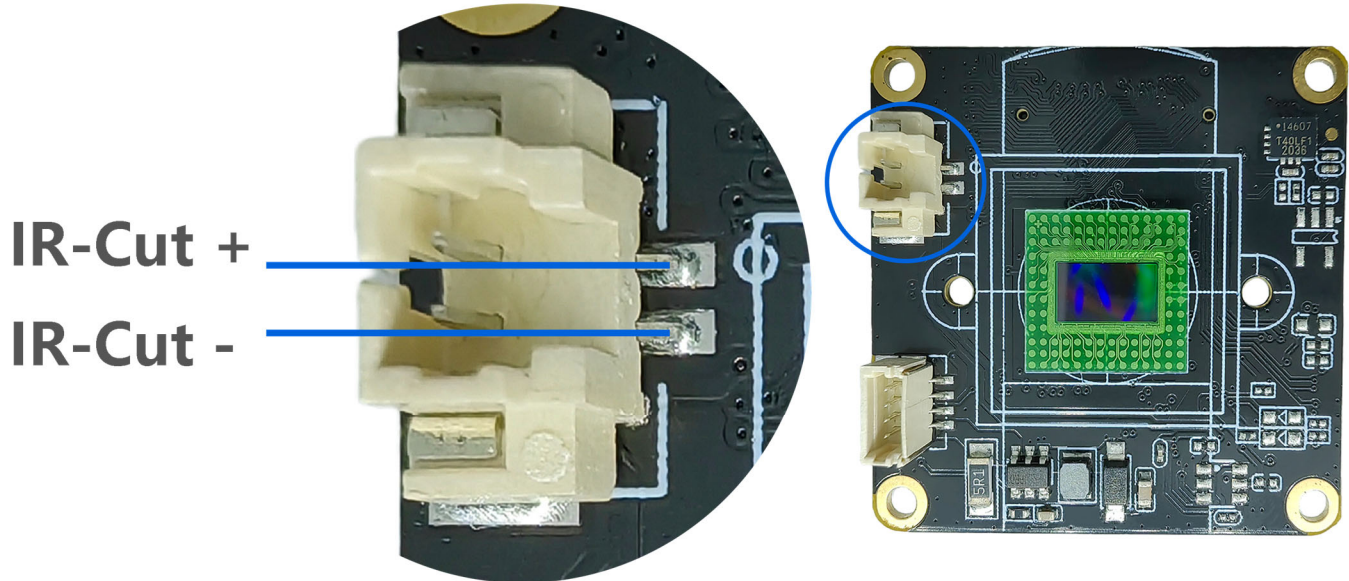

The IR-Cut filter switch interface is used by lenses with filters. Users need to match the lens that supports the IR-Cut switch structure in order to support this function.

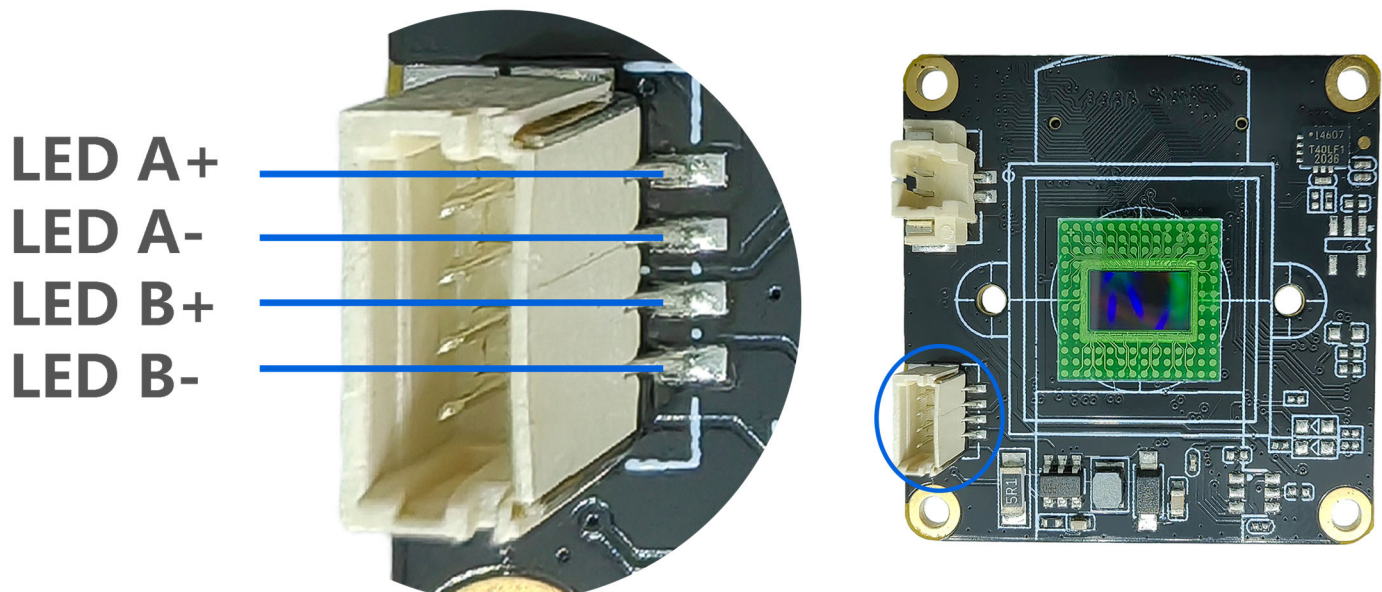

The two sets of fill light interfaces support the expansion of infrared light and white light boards to provide fill light for the device. If you need the fill light function, you need to add the KLT-LEDP V2.0 White and Infrared Light LED Plate.

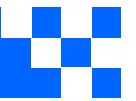
**KLT-CMNL-OS12D40 V1.0****11.3MP OmniVision OS12D40 No Lens Camera Module**

**通过板对板连接器连接G1主板
支持Sensor、EIS、IR-CUT、LED等**
Connect Sensor, EIS, IR-CUT, LED etc.

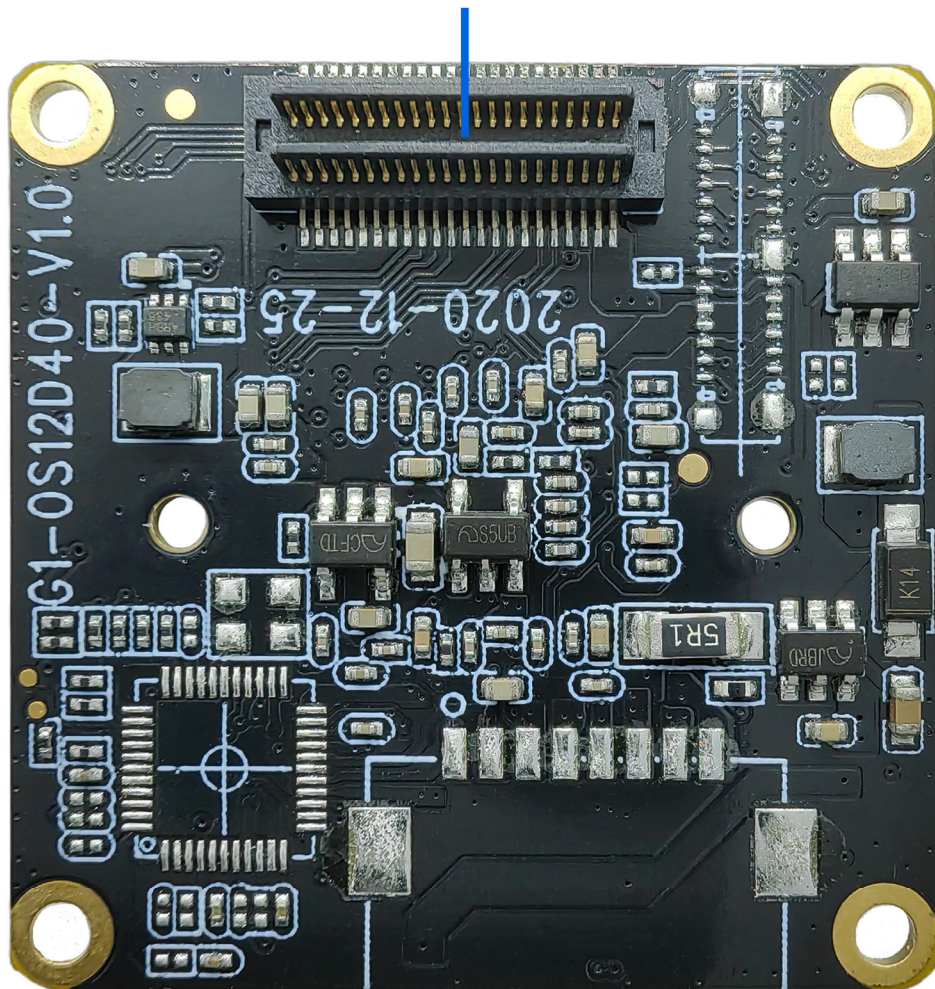

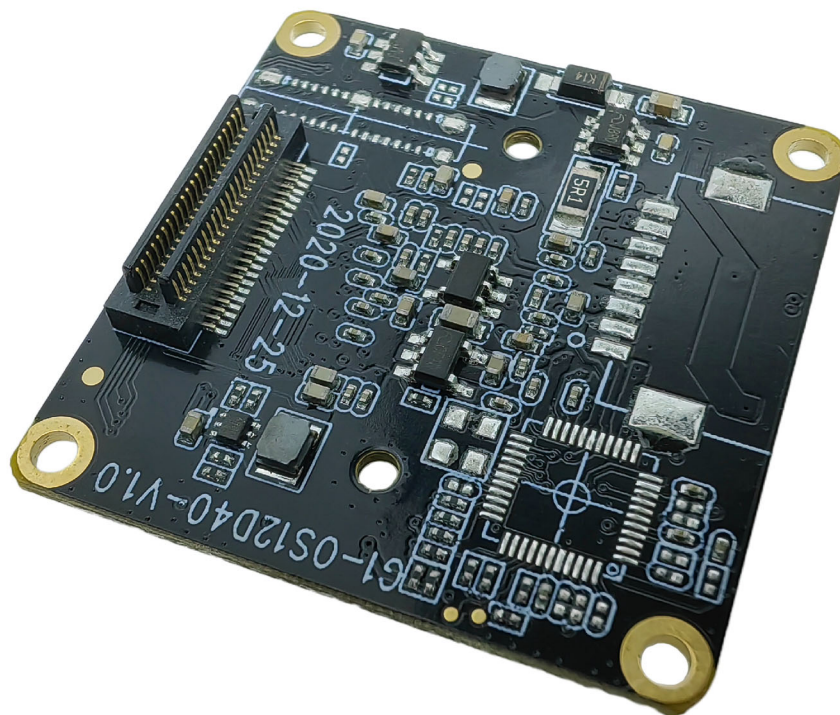
**KLT-CMNL-OS12D40 V1.0****11.3MP OmniVision OS12D40 No Lens Camera Module**

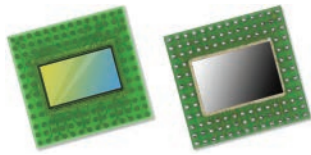

OS12D40 11.3-megapixel product brief



available in
a lead-free
package

Security Image Sensor Provides Industry-High 11.3MP Resolution for 4K2K With Electronic Image Stabilization and Best in Class HDR for 1080p Video

OmniVision's OS12D40 is a 1.4 micron pixel, 11.3MP image sensor that offers the unprecedented combination of a large 1/2.49" optical format, on-chip remosaic (4-cell to Bayer) color converter and on-chip high dynamic range (HDR) processing. It is the industry's only security sensor with 3-exposure, 4-cell HDR capability to provide larger-pixel low light performance with the best artifact elimination for moving objects. When in full-HD 1080p mode, this sensor's 3-exposure HDR with on-chip combination and tone mapping provides best in class video captures. This is superior to the competing method, known as staggered HDR, which relies on additional passes that introduce motion artifacts, especially in low light.

Integrated selective conversion gain technology allows the pixel conversion gain to be dynamically switched between low and high, depending on the scene being captured. In combination with its other features—including PureCel[®]Plus-S stacked pixel technology for reduced cross talk and maximum quantum efficiency in low light—this image sensor enables mass market security cameras to capture the industry's highest quality video and ultra wide angle photos.

The OS12D40's fast mode switch allows security operators or AI-enabled surveillance systems to seamlessly switch to 4K2K mode when a specific threat is identified for closer inspection, such as a potential intruder or unauthorized vehicle. This sensor's best in class 11.3MP resolution provides the extra pixels needed for 4K2K images with electronic image stabilization (EIS), to ensure that details can be clearly identified.

The OS12D40 is a native 16:9 aspect ratio image sensor that uses a 4-cell color filter pattern. It has an on-chip 4-cell to Bayer remosaic converter, in order to provide 4K video at 60 fps with 20% additional pixels for EIS. In a 4-cell binned mode, it can output an impressive 2.8MP/1080p resolution with 20% additional pixels for EIS video and images at four times the sensitivity. This sensor also supports both CPHY and DPHY interfaces.

Find out more at www.ovt.com.



OmniVision

Applications

- Security Cameras
- PC Multimedia
- Machine Vision

Product Features

- automatic black level calibration (ABL)
- programmable controls for:
 - frame rate
 - mirror and flip
 - binning
 - cropping
 - windowing
- support for dynamic defect pixel cancellation (DPC)
- supports output formats: 10-bit RGB 4-cell pattern Bayer RAW
- supports horizontal and vertical subsampling
- supports typical images sizes:
 - 4512 x 2512
 - 3840 x 2160
 - 2256 x 1256
 - 1920 x 1080
 - 1280 x 720
- standard serial SCCB interface
- up to 4-lane MIPI TX interface with speed up to 2.5 Gbps/lane
- embedded 8k bits of one-time programmable (OTP) memory (4k bits reserved for customer use)
- 2/3 trio C-PHY interface, up to 1.6 Gbps/trio
- 4-cell support:
 - 4-cell binning
 - 4-cell full
- on-chip 4-cell to Bayer converter
- three on-chip phase lock loops (PLLs)
- sequential multi-frame HDR
- 2.8MP 10-bit 3-exposure 4C HDR output after tone mapping
- programmable I/O drive capability
- built-in temperature sensor
- typical module size: 8.5 x 8.5 x -5.1 mm

OS12D40



Ordering Information

- OS12D40-J08A-Z (color, lead-free)
108-pin fan-out package

Technical Specifications

- active array size: 4512 x 2512
- maximum image transfer rate:
 - 4512 x 2512: 60 fps
- power supply:
 - core: 1.1V
 - analog: 2.8V
 - I/O: 1.8V
- power requirements:
 - active: 505 mW
 - standby: <10 μW
- temperature range:
 - operating: -30°C to +85°C junction temperature
 - stable: 0°C to +60°C junction temperature
- output formats:
 - 10-bit RGB 4-cell pattern Bayer RAW
- lens size: 1/2.49"
- lens chief ray angle: 8.7° linear
- scan mode: progressive
- pixel size: 1.404 μm x 1.404 μm
- image area: 6365.736 μm x 3554.928 μm

Functional Block Diagram

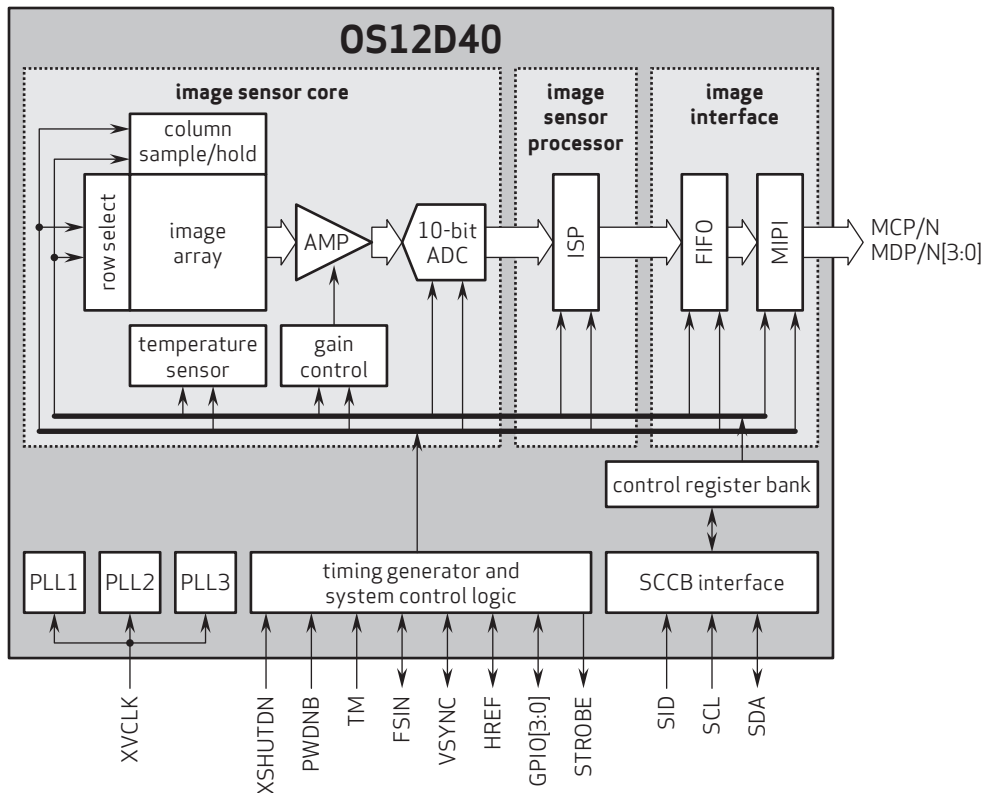

4275 Burton Drive
Santa Clara, CA 95054
USA

Tel: +1 408 567 3000
Fax: +1 408 567 3001
www.ovt.com

OmniVision reserves the right to make changes to their products or to discontinue any product or service without further notice. OmniVision, the OmniVision logo and PureCel are registered trademarks of OmniVision Technologies, Inc. All other trademarks are the property of their respective owners.



OmniVision



Cameras Applications



Automotive Driver Pilot



Live Streaming



Video Conference



Eye Tracker Biometric Detection



Machine Vision



Agricultural Monitor



Night Vision Security



Drone and Sports Eagle Eyes



Interactive Pet Camera



your BEST camera module partner

Cameras Applications

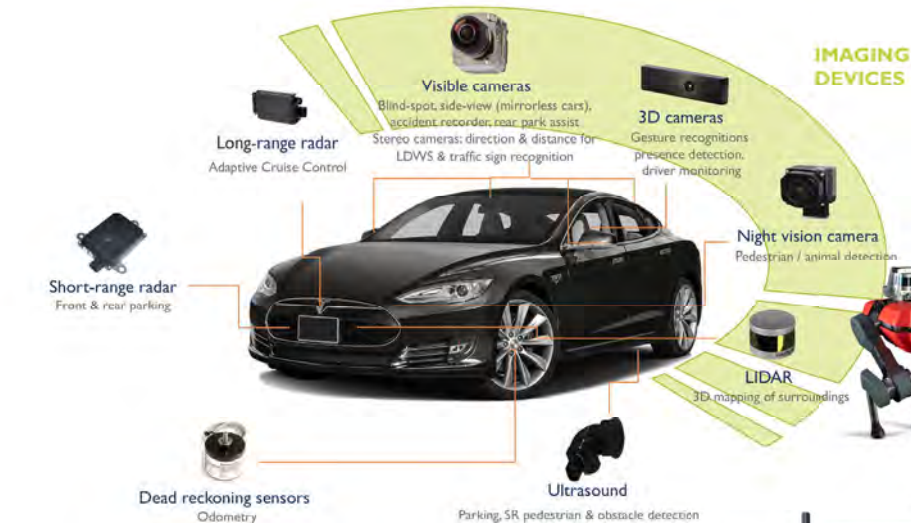



Camera Module Pinout Definition Reference Chart

OmniVision	Sony	Samsung	On-Semi	Aptina	Himax	GalaxyCore	PixArt	SmartSens	Sensors
Pin Signal									
Description									
DGND	GND								
AGND									
PCLK	DCK								
XCLR	PWDN	XSHUTDOWN	STANDBY						
MCLK	XVCLK	XCLK	INCK						
RESET	RST								
NC	NULL								
SDA	SIO_D	SIOD							
SCL	SIO_C	SIOC							
VSYNC	XVS	FSYNC							
HREF	XHS								
DOVDD									
AFVDD									
AVDD									
DVDD									
STROBE	FSTROBE								
FSIN									
SID									
ILPWM									
FREX									
GPIO									
SLASEL									
AFEN									
MIPI Interface									
MDN0	DN0	MD0N	DATA_N	DMO1N					
MDP0	DP0	MD0P	DATA_P	DMO1P					
MDN1	DN1	MD1N	DATA2_N	DMO2N					
MDP1	DP1	MD1P	DATA2_P	DMO2P					
MDN2	DN2	MD2N	DATA3_N	DMO3N					
MDP2	DP2	MD2P	DATA3_P	DMO3P					
MDN3	DN3	MD3N	DATA4_N	DMO4N					
MDP3	DP3	MD3P	DATA4_P	DMO4P					
MCN	CLKN	CLK_N	DCKN						
MCP	CLKP	MCP	CLK_P	DCKN					
DVP Parallel Interface									
D0	DO0	Y0							
D1	DO1	Y1							
D2	DO2	Y2							
D3	DO3	Y3							
D4	DO4	Y4							
D5	DO5	Y5							
D6	DO6	Y6							
D7	DO7	Y7							
D8	DO8	Y8							
D9	DO9	Y9							
D10	DO10	Y10							
D11	DO11	Y11							



Camera Reliability Test

Reliability Inspection Item		Testing Method	Acceptance Criteria	
Category	Item			
Environmental	Storage Temperature	High 60°C 96 Hours	Temperature Chamber	No Abnormal Situation
		Low -20°C 96 Hours	Temperature Chamber	No Abnormal Situation
	Operation Temperature	High 60°C 24 Hours	Temperature Chamber	No Abnormal Situation
		Low -20°C 24 Hours	Temperature Chamber	No Abnormal Situation
	Humidity	60°C 80% 24 Hours	Temperature Chamber	No Abnormal Situation
	Thermal Shock	High 60°C 0.5 Hours Low -20°C 0.5 Hours Cycling in 24 Hours	Temperature Chamber	No Abnormal Situation
Physical	Drop Test (Free Falling)	Without Package 60cm	10 Times on Wood Floor	Electrically Functional
		With Package 60cm	10 Times on Wood Floor	Electrically Functional
	Vibration Test	50Hz X-Axis 2mm 30min	Vibration Table	Electrically Functional
		50Hz Y-Axis 2mm 30min	Vibration Table	Electrically Functional
		50Hz Z-Axis 2mm 30min	Vibration Table	Electrically Functional
	Cable Tensile Strength Test	Loading Weight 4 kg 60 Seconds Cycling in 24 Hours	Tensile Testing Machine	Electrically Functional
Electrical	ESD Test	Contact Discharge 2 KV	ESD Testing Machine	Electrically Functional
		Air Discharge 4 KV	ESD Testing Machine	Electrically Functional
	Aging Test	On/Off 30 Seconds Cycling in 24 Hours	Power Switch	Electrically Functional
	USB Connector	On/Off 250 Times	Plug and Unplug	Electrically Functional





Inspection Item		Inspection Method	Standard of Inspection		
Category	Item				
Appearance	FPC/ PCB	Color	The Naked Eye	Major Difference is Not Allowed.	
		Be Torn/Chopped	The Naked Eye	Copper Crack Exposure is Not Allowed.	
		Marking	The Naked Eye	Clear, Recognizable (Within 30cm Distance)	
	Holder	Scratches	The Naked Eye	The Inside Crack Exposure is Not Allowed	
		Gap	The Naked Eye	Meet the Height Standard	
		Screw	The Naked Eye	Make Sure Screws Are Presented (If Any)	
		Damage	The Naked Eye	The Inside Crack Exposure is Not Allowed	
	Lens	Scratch	The Naked Eye	No Effect On Resolution Standard	
		Contamination	The Naked Eye	No Effect On Resolution Standard	
		Oil Film	The Naked Eye	No Effect On Resolution Standard	
		Cover Tape	The Naked Eye	No Issue On Appearance.	
	Function	Image	No Communication	Test Board	Not Allowed
			Bright Pixel	Black Board	Not Allowed In the Image Center
Dark Pixel			White board	Not Allowed In the Image Center	
Blurry			The Naked Eye	Not Allowed	
No Image			The Naked Eye	Not Allowed	
Vertical Line			The Naked Eye	Not Allowed	
Horizontal Line			The Naked Eye	Not Allowed	
Light Leakage			The Naked Eye	Not Allowed	
Blinking Image			The Naked Eye	Not Allowed	
Bruise			Inspection Jig	Not Allowed	
Resolution			Chart	Follows Outgoing Inspection Chart Standard	
Color			The Naked Eye	No Issue	
Noise			The Naked Eye	Not Allowed	
Corner Dark			The Naked Eye	Less Than 100px By 100px	
Color Resolution			The Naked Eye	No Issue	
Dimension	Height	The Naked Eye	Follows Approval Data Sheet		
	Width	The Naked Eye	Follows Approval Data Sheet		
	Length	The Naked Eye	Follows Approval Data Sheet		
	Overall	The Naked Eye	Follows Approval Data Sheet		



KLT Package Solutions

KLT Camera Module

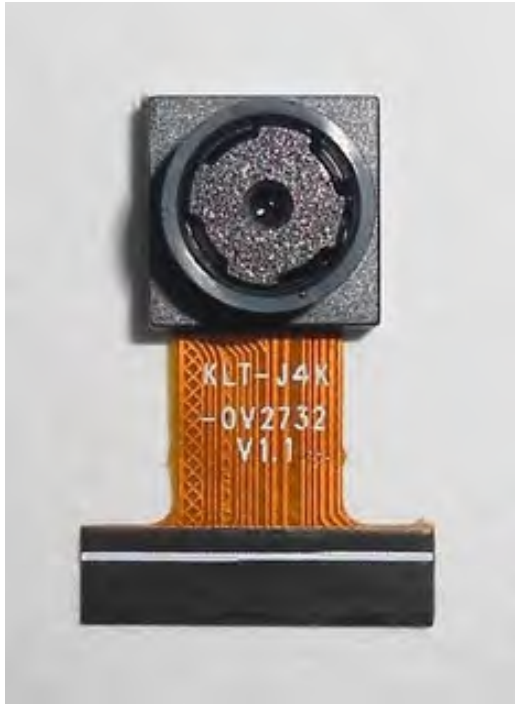

Complete with Lens Protection Film



Tray with Grid and Space



Place Cameras on the Tray





Camera Modules Package Solution

Full Tray of Cameras

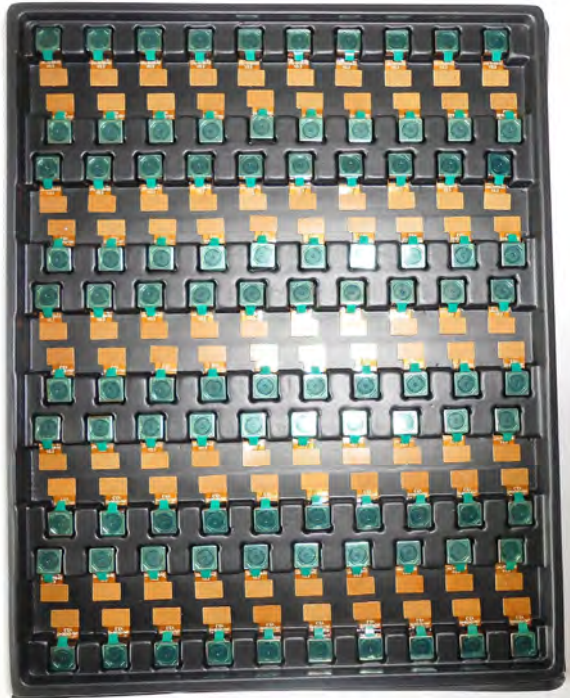

Cover Tray with Lid



Put Tray into Anti-Static Bag



Vacuum the Anti-Static Bag

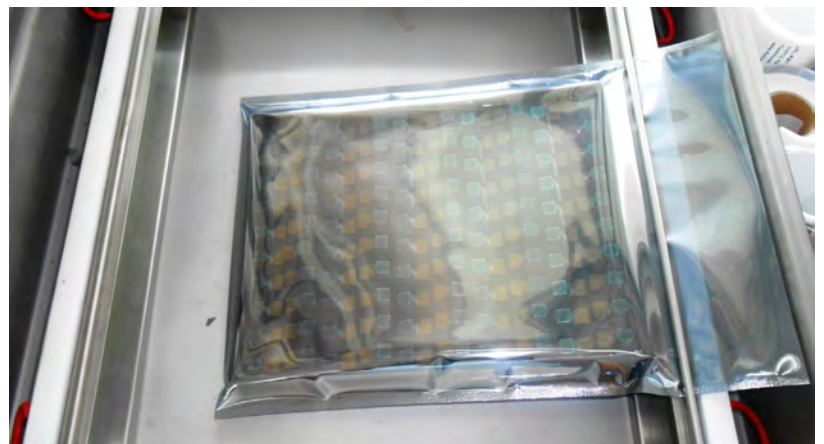



Camera Modules Package Solution

Sealed Vacuum Bag with Labels

1. Model and Description 2. Quantity 3. Shipping Date 4. Caution





Large Order Package Solution

Place Foam Sheets Between Trays



Foam Sheets are Slightly Larger than Trays



Place Foam Sheets and Trays into Box



Foam Sheets are Tightly Fitting Box





Small Order Package Solution

Place Foam Sheets and Trays into Small Box



Foam Sheets are Nicely Fitting the Small Box



Package in Small Box for Shipment



Place Small Boxes into Larger Box





your BEST camera module partner

Carbon Box Package Solution

Seal the Carbon Box

Final Package Labelled Box



Carbon Box Ready for Shipment

1. Delivery Address and Phone No. 2. Box No. and Ship Date 3. Fragile Caution





Sample Order Package Solution

Place Sample into Small Anti-Static Bag



Place Connectors into Small Ant-Static Bag



Sample Labels on the Small Bag

1. Camera Module or Connector Model 2. Shipping Date and Quantity 3. Caution





Connectors Large Order Package Solution

Connectors in a Wheel



Label Connectors in the Wheel



The Wheel is Perfectly Fitting the Box



Connectors Box Ready for Shipment





Company Kai Lap Technologies (KLT)

Kai Lap Technologies Group Limited. (KLT) was established in 2009, a next-generation technology driven manufacturer specialized in research, design, and produce of audio and video products. KLT is occupying 20,000 square feet automated plants with 100 employees of annual throughput 30,000,000 units cameras.

KLT provides OEM, ODM design, contract manufacturing, and builds the camera products. You may provide the requirements to us, even with a hand draft, our sales and engineering work together to meet your needs. We consider ourselves your last-term partner in developing practical and innovative solutions.

Our team covers everything from initial concept development to mass produced product. KLT specializes in customized camera design, raw material, electronic engineering, firmware/software development, product testing, and packing design. Our experienced strategic supply systems offer a robust and dependable manufacturing capacity for orders of various sizes.

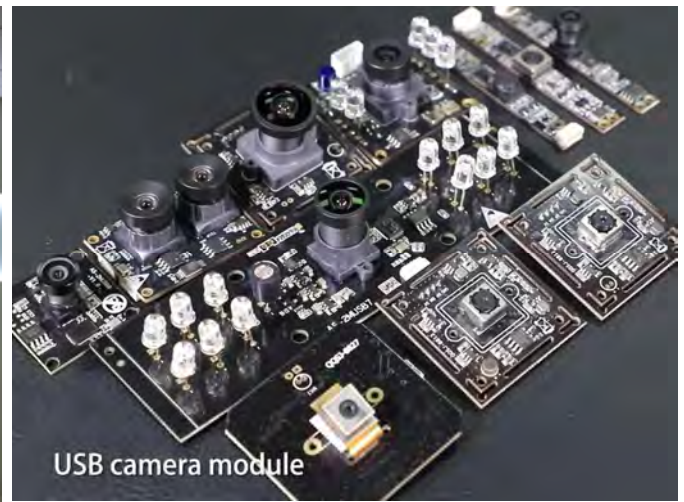

Limited Warranty

KLT provides the following limited warranty if you purchased the Product(s) directly from KLT company or from KLT's website, www.KaiLapTech.com. Product(s) purchased from other sellers or sources are not covered by this Limited Warranty. KLT guarantees that the Product(s) will be free from defects in materials and workmanship under normal use for a period of one (1) year from the date you receive the product ("Warranty Period").

For all Product(s) that contain or develop material defects in materials or workmanship during the Warranty Period, KLT will, at its sole option, either: (i) repair the Product(s); (ii) replace the Product(s) with a new or refurbished Product(s) (replacement Product(s) being of identical model or functional equivalent); or (iii) provide you a refund of the price you paid for the Product(s).

This Limited Warranty of KLT is solely limited to repair and/or replacement on the terms set forth above. KLT is not reliable or responsible for any subsequent events.





CMOS CAMERA MODULES



your BEST camera module partner

KLT Strength

Powerful Factory



Professional Service



Promised Delivery



www.KaiLapTech.com sales@KaiLapTech.com Tel: (852) 6908 1256 Fax: (852) 3017 6778

All rights reserved @ Kai Lap Technologies Group Ltd. Specifications subject to change without notice.